

EO 5140-1B LED

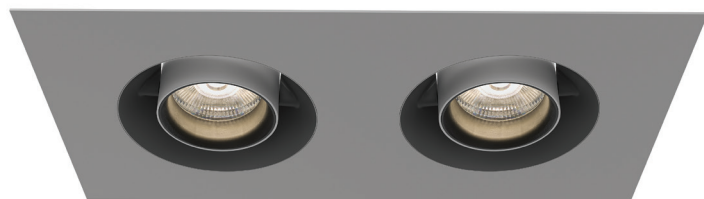

EO 5140-2B LED

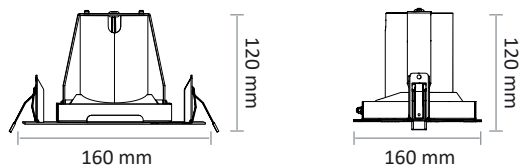
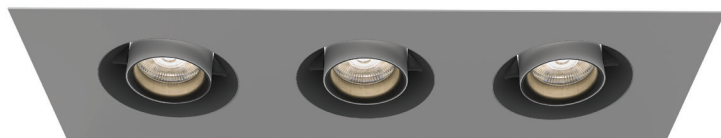
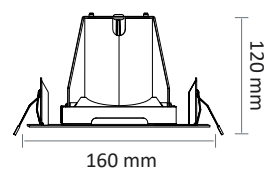
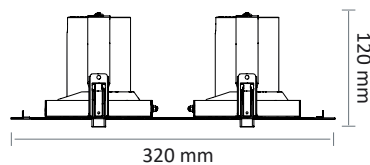

EO 5140-3B LED

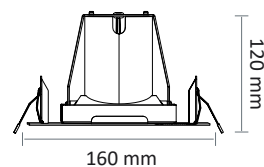
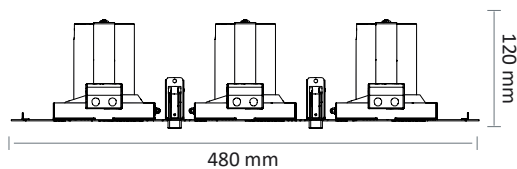

Couleur(s) collerette



# EO 5140-1B2B3B ICOB LED

# ENCASTRÉS ORIENTABLES ■ LED

- Encastré orientable pour module LED SPOT, maximum 3x2 784 lumens
- IRC de 90
- Ellipse de MacAdam : 2 SDCM
- Disponible en 3 000 K, 3 500 K et 4 000 K
- Durée de vie 50 000 heures (L80B10)
- Efficacité lumineuse du système de 144,3 lm/W
- Installation facilitée par des ressorts en pression
- Colerette en acier peint
- Optique lentille polycarbonate
- **Poids** : Approx. 1,3 kg
- **Convertisseur(s)** : Fixe, Gradation DALI (CDIMMDALI), Casambi, Connect
- **Option(s)** : Connectique rapide (CORD)
- Groupe de risque photobiologique 1

## Convertisseur(s)



## Normes

Classe II | IP 20 | 650° | RG1

## Faisceau(x)



## Option(s)

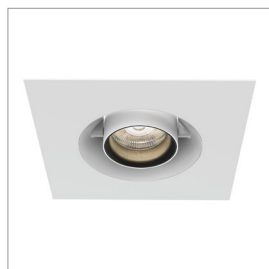

Colerette blanche  
Bague blanche



Colerette noire  
Bague blanche



Colerette grise  
Bague blanche



Colerette blanche  
Bague noire



Colerette noire  
Bague noire



Colerette grise  
Bague noire

## Version ICOB

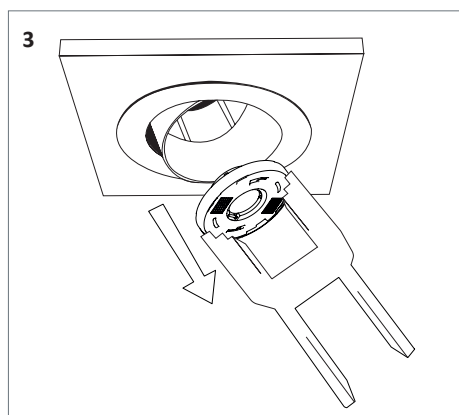
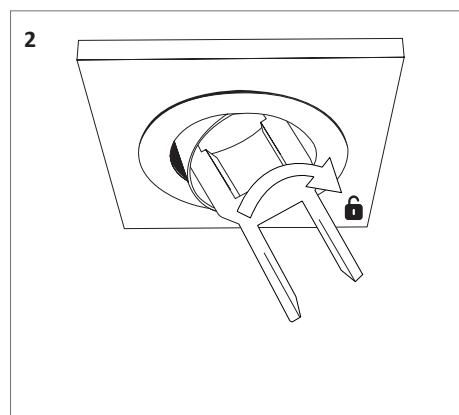
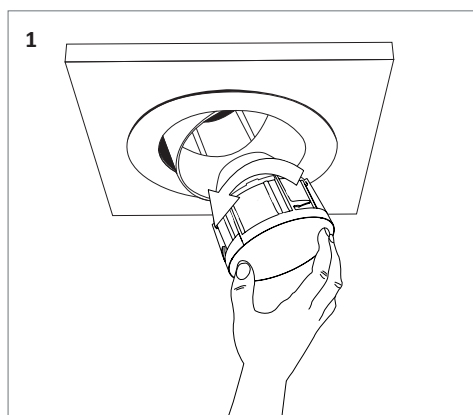

## Performance des modules à haute efficacité (HE) IRC 90 avec R9>80

RÉFÉRENCE	PUISSANCE	CONSOMMATION	FLUX LUMINEUX	EFFICACITÉ DU SYSTÈME	TEMPÉRATURE DE COULEUR	IRC	CLASSE D'EFFICACITÉ ÉNERGÉTIQUE
EO 5140-1B LED ICOB HE 2800-930	16,6 W	19,3 W	2771 lumens	143,6 lm/W	3000 K	90	E
EO 5140-1B LED ICOB HE 2800-935	16,6 W	19,3 W	2752 lumens	142,6 lm/W	3500 K	90	E
EO 5140-1B LED ICOB HE 3000-940	16,6 W	19,3 W	2784 lumens	144,3 lm/W	4000 K	90	E
EO 5140-2B LED ICOB HE 2800-930	2x16,6 W	2x19,3 W	2x2771 lumens	143,6 lm/W	3000 K	90	E
EO 5140-2B LED ICOB HE 2800-935	2x16,6 W	2x19,3 W	2x2752 lumens	142,6 lm/W	3500 K	90	E
EO 5140-2B LED ICOB HE 3000-940	2x16,6 W	2x19,3 W	2x2784 lumens	144,3 lm/W	4000 K	90	E
EO 5140-3B LED ICOB HE 2800-930	3x16,6 W	3x19,3 W	3x2771 lumens	143,6 lm/W	3000 K	90	E
EO 5140-3B LED ICOB HE 2800-935	3x16,6 W	3x19,3 W	3x2752 lumens	142,6 lm/W	3500 K	90	E
EO 5140-3B LED ICOB HE 3000-940	3x16,6 W	3x19,3 W	3x2784 lumens	144,3 lm/W	4000 K	90	E