

# AR 2281 LED



## Colour(s)



# HIGH BAY ■ LED

- High bay for LED SPOT module, maximum 7 225 lumens
- CRI of 80 or 90
- MacAdam Ellipse: 2 SDCM
- Available in 2 700 K, 3 000 K, 3 500 K and 4 000 K
- 50 000 hours lamp life (L80B10)
- Luminous efficiency of system up to 152 lm/W
- Housing made of painted die-cast aluminium
- **Driver(s):** Fixed, Dimmable driver DALI (CDIMMDALI)

## Driver(s)



## Standards

Class I | IP 20 | 650°

## Beam(s)



## Dimensions

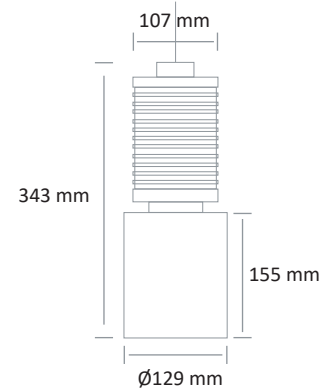

ITEM	POWER	CONSUMPTION	LUMINOUS FLUX	SYSTEM EFFICIENCY	COLOUR TEMPERATURE	CRI	EFFICIENCY ENERGY CLASS
AR 2281 LED 3000-927	23W	25W	2700 lumens	108 lm/W	2700 K	90	E
AR 2281 LED 3000-930	23W	25W	2800 lumens	112 lm/W	3000 K	90	E
AR 2281 LED 3000-935	23W	25W	2850 lumens	114 lm/W	3500 K	90	E
AR 2281 LED 3000-940	23W	25W	3000 lumens	120 lm/W	4000 K	90	E
AR 2281 LED 3500-830	23W	25W	3450 lumens	138 lm/W	3000 K	80	D
AR 2281 LED 3500-840	23W	25W	3525 lumens	141 lm/W	4000 K	80	D
AR 2281 LED 4000-927	39W	43W	3925 lumens	91,3 lm/W	2700 K	90	E
AR 2281 LED 4000-930	39W	43W	4075 lumens	94,8 lm/W	3000 K	90	E
AR 2281 LED 4000-935	39W	43W	4150 lumens	96,5 lm/W	3500 K	90	E
AR 2281 LED 4000-940	39W	43W	4350 lumens	101,2 lm/W	4000 K	90	E
AR 2281 LED 5000-830	39W	43W	5025 lumens	116,9 lm/W	3000 K	80	D
AR 2281 LED 5000-840	39W	43W	5150 lumens	119,8 lm/W	4000 K	80	D
AR 2281 LED 6000-927	49W	55W	5525 lumens	100,4 lm/W	2700 K	90	E
AR 2281 LED 6000-930	49W	55W	5750 lumens	104,5 lm/W	3000 K	90	E
AR 2281 LED 6000-935	49W	55W	5825 lumens	105,9 lm/W	3500 K	90	E
AR 2281 LED 6000-940	49W	55W	6125 lumens	111,4 lm/W	4000 K	90	E
AR 2281 LED 7000-830	49W	55W	7050 lumens	128,1 lm/W	3000 K	80	D
AR 2281 LED 7000-840	49W	55W	7225 lumens	131,4 lm/W	4000 K	80	D